



WT2GO

Constant Pressure Water Supply Unit



OPERATOR'S MANUAL

Table of Contents

INTRODUCTION	1
DISCLAIMER	1
ABOUT THIS MANUAL.....	2
KEY TERMS	2
PRODUCT INFORMATION	3
SAFETY INFORMATION	3
SAFETY DECALS	4
PRODUCT DESCRIPTION AND SPECIFICATIONS	4
OPERATION	6
BEFORE USE	6
MAINTENANCE	8
GENERAL RECOMMENDATIONS:	9
WT2GO SPECIFIC MAINTENANCE	9
STORAGE	10
TROUBLESHOOTING.....	11
SPARE PARTS	12

INTRODUCTION

Thank you for purchasing a Husqvarna product.

This manual provides information and procedures to safely operate and maintain the **WT2GO**. For yours and/or other's safety and protection from injury, carefully read, understand and observe the safety instructions described in this manual.

Keep this manual or a copy of it with the machine. If you lose this manual or need an additional copy, please contact Husqvarna. This machine is designed and built with user safety in mind; however, it can present hazards if improperly operated and/or serviced. Please follow the operating instructions carefully. If there are any questions regarding operating or servicing of this product, please contact Husqvarna.

The information contained in this manual was based on devices in production at the time of publication. Husqvarna reserves the right to change any portion of this information without notice.

All rights, especially copying and distribution rights are reserved.

Copyright 2019 by Husqvarna.

No part of this publication may be reproduced in any form or by any means, electronic or mechanical, including photocopying, without express written permission from Husqvarna.

Any type of reproduction or distribution not authorized by Husqvarna represents an infringement of valid copyrights and will be prosecuted. We expressly reserve the right to make technical modifications, without due notice, which aim at improving our machines or their safety standards.

DISCLAIMER

Husqvarna and its affiliates take no responsibility for any damage, injury or death resulting from the incorrect or unsafe use of this product. Use of this product should be undertaken by competent persons only. It is the operator's responsibility to ensure that the following safety procedures are followed. If you are unsure, do not operate this product.

Record the model and serial numbers as well as date and place of purchase for future reference. Have this information available when ordering parts and when making technical or warranty inquiries

HUSQVARNA SUPPORT

Please contact your local Husqvarna agent

MODEL NO.

SERIAL NO.

DATE OF PURCHASE

PURCHASE LOCATION

ABOUT THIS MANUAL

This manual uses the following symbols to help differentiate between different kinds of information. The safety symbol is used with a key word to alert you to potential hazards in operating and owning WT2GO. Follow all safety messages to avoid or reduce the risk of serious injury or death.

KEY TERMS

 READ CAREFULLY	READ CAREFULLY – refers to <i>important information</i> that should be paid careful attention.
--	---

 CAUTION	CAUTION - indicates a potential hazardous situation which, if not avoided, <i>may</i> result in minor or moderate injury
---	---

 WARNING	WARNING – indicates a potentially hazardous situation which, if not avoided, <i>could</i> result in death or serious injury
--	--

 DANGER	DANGER – indicates an imminently hazardous situation which, if not avoided, <i>will</i> result in death or serious injury
--	--

 PROHIBITED	PROHIBITED – identifies actions that <i>should never</i> be carried out by any one interacting with the machine.
--	---

These safety warnings do not eliminate all possible hazards that could occur therefore it is essential to use common sense and to strictly follow any instructions to prevent accidents.

PRODUCT INFORMATION

SAFETY INFORMATION



Read this manual **thoroughly** before operating your WT2GO. Failure to follow instructions could result in serious injury or death.



Husqvarna WT2GO is designed for ease of use and safety. However, damage to the device and personal injury is possible if used incorrectly. Instruct all operators in care and use of the machine before use.



RISK OF EXPLOSION

Contents of device are under pressure (even when empty). **Do not attempt to disassemble device** as serious injury may occur. Warranty is voided if disassembled (other than by registered service agent).



RISK OF EXPLOSION OR DAMAGE TO DEVICE

Device is designed for use on water main's pressure and has been tested to 70 Psi. Do not connect to sources which you feel may exceed this pressure. i.e. stand pipe into water main, hydrant without pressure reducer, irrigation pump, etc. Doing so will void warranty.

- **ALWAYS** wear PPE appropriate to task; such as goggles, ear muffs, gloves, and closed foot wear.
- **ALWAYS** use recommended hose fittings as they are tested at rated pressure. Use of non-genuine accessories may reduce performance and/or working life of device.
- **ALWAYS** use care in filling tanks and ensure that a firm connection is made between connectors.
- **ALWAYS** Make sure connectors/hose are free of debris that could obstruct/damage device.
- **NEVER** introduce foreign agents (i.e. soaps, solvents, colours, etc.) to device. Doing so will void warranty.
- **ALWAYS** follow manufacturer's recommendations, including those of equipment used in conjunction with WT2GO (for example; Concrete saw user's manual)



RISK OF FALL HAZARD

- Use of WT2GO can create puddles and slippery surfaces.

- Keep operating area clear of obstacles.
- **DO NOT** operate the machine with missing, broken, or non-genuine parts.

- DO NOT drag the device using only the hose as this may cause damage to the device and/or fittings.
- NEVER spray near power source.

 WARNING	<p style="text-align: center;">RISK OF ELECTRICAL SHOCK</p> <ul style="list-style-type: none">• Risk of electrocution.• Be aware of electrical hazards whilst performing task as contact with power source may cause electric shock.
---	--

SAFETY DECALS



PRODUCT DESCRIPTION AND SPECIFICATIONS

The Husqvarna WT2GO is a constant pressure water supply device. It is designed and engineered to simplify the process of supplying water in situations where regular hosing is difficult. The WT2GO includes a multi-function nozzle, an on/off valve, 3 metres of reinforced hose, all mounted on a compact two chamber frame design.

Husqvarna	
WT2GO	
OVERALL WEIGHT - Empty	6kg/13.2lb
OVERALL WEIGHT – Full	20kg/44lb
OVERALL WIDTH	325mm/12.8inch
OVERALL HEIGHT	800mm/31.5inch
OVERALL DEPTH	144mm/5.7inch
HOSE LENGTH	3m/18ft
PRESSURE OUTPUT	7-10psi
FLOW RATE	Approx. 0.5 – 7.0 L/min (0.13 - 1.85 gal/min)

OPERATION

BEFORE USE

1. Inspect device

- 1.1 Check for any damage. Check for loose or missing fasteners (2x nut/bolt in base & 2x screws in handle).



- 1.2 Ensure all fittings are tight (do not over tighten using tools as damage may occur to fittings).

NOTE: IMPROPER treatment of WT2GO can damage it and shorten its working life.

DO NOT attempt to open device to alter or to repair it. This must **ONLY** be done by Husqvarna approved service technician.

FILLING



Using high-pressure pumps, direct connection to water mains or other high-pressure sources to fill WT2GO that exceed rated pressure (70 psi) will void warranty.

- **Only** use water.
- DO NOT mix with oil, detergents, etc.
- DO NOT modify device in any way.

To fill WT2GO, observe the following steps:

2.1 Attach hose adaptor to the tap



2.2 Attach the hose plug to a tap

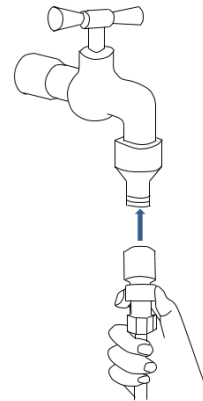

2.3 Turn tap on fully open

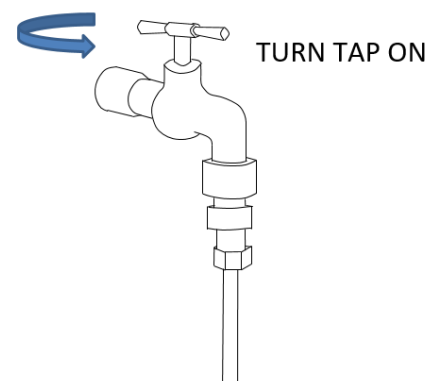

2.4 Allow WT2GO to fill.

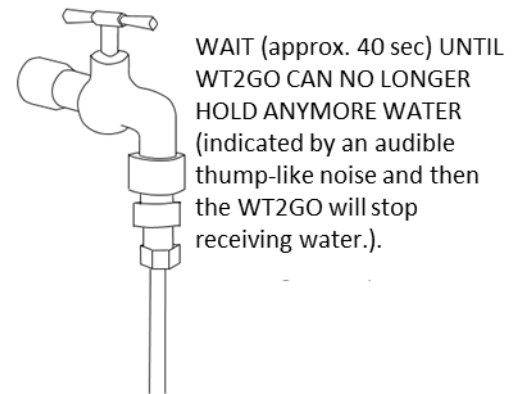

2.5 Turn tap off

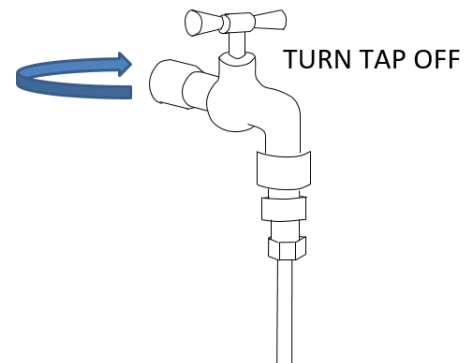

2.6 Remove the hose plug/connector from the tap

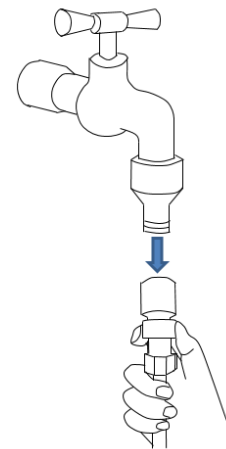

2.7 Connect the WT2GO to desired application and use as required (i.e. concrete cutter, core drill, etc.)

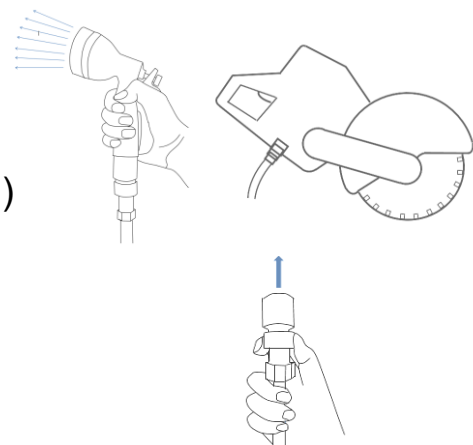

MAINTENANCE

GENERAL RECOMMENDATIONS:

Regular maintenance will improve the performance and extend the life of your Husqvarna product.

The WT2GO warranty does not cover items that have been subjected to operator abuse or negligence or disassembly.

Should you have questions about replacing components on your WT2GO, please contact your dealer/service workshop for assistance.

WT2GO SPECIFIC MAINTENANCE

This device is designed for the rigours of the construction industry. However, care is still required to maximise its working life. If the instructions in this manual are heeded, you can expect a long and rewarding service from your Husqvarna WT2GO.

<p>NOTE: IMPROPER treatment of WT2GO can damage it and shorten its life.</p>

Cleaning

Hose and wipe down WT2GO using soapy water be cautious not to introduce debris into inner workings.

Using a high-pressure washer is **not** recommended as this could strip the decals on the device.

Do not clean internally with soaps or other cleaning agents, rinse with fresh water and empty to store.

Clear Debris

Before use, clear debris from hose line. If debris has entered the hose line disconnect from WT2GO base (be aware that if the device is full water will spray out) and connect the free hose to a tap, flush out any debris before reconnecting and refilling WT2GO.

Check multi spray nozzle

Ensure nozzle is connected securely and functioning correctly. Selector should rotate between options smoothly with a slight click at each function.

Check one-way valve

Inspect one-way valve on hose fitting and ensure it is working correctly. Ensure no debris is in mechanism.

Threaded fittings

Check threaded fittings are tight to ensure a good seal. Do not use hand tools to over tighten threaded fittings as damage may occur.

Tools can be used to **gently** loosen fittings on hose if required.

The barb fitting on the top lid of the device can be tightened/loosened by hand. Use cloth to improve grip if tight. Use of multi grip plyers may be required if too tight. Use gently avoiding damage to barb and WT2GO top lid frame.

STORAGE

Long term storage instructions

It is not advised to store a **full** WT2GO for long periods (weeks/months) as this may reduce performance of your product. Empty your WT2GO before long-term storage.

Do not clean inside tanks with soaps or other cleaning agents/products, rinse with fresh water and empty.

TROUBLESHOOTING

TROUBLE SHOOTING GUIDE		
PROBLEM	CAUSE	REMEDY
Pump does not fill	Valve faulty	Inspect valve on hose
	Blockage in hose	Remove hose from WT2GO and flush with tap water from either end Check for blockages at barbed fittings
	Blockage in top cap	Inspect inlet for debris
Irregular variations in pressure	Machine being used has blockage	Refer to applicable machine's operator manual
	Valves blocked by debris	Clean the valves
	Air in system	Follow instructions on device to fill from empty
	Hose blocked by debris	Remove hose from WT2GO and flush with tap water from either end
Pressure drop	Tank empty	Fill following procedure in manual/ and on WT2GO
	Blockage in hose	Remove hose from WT2GO and flush with tap water from either end
	Faulty valve	Inspect valves for blockages/damage
Water leaking from main housing	Ruptured bladder	Contact your servicing dealer
	Cracked housing	Contact your servicing dealer
	Water accumulated whilst stowed on side	When stowed on side or upside-down water can accumulate in upper housing. This is normal do not confuse with leaking.

SPARE PARTS

#	Husqvarna Part no	Description
1	598765801	(HOSE With Screw and QC Fitting H2G-05)
2	598768201	CONNECTOR Quick Connect with Stop
3	598767801	(SPRAY GUN H2G-09)
4	598766301	SCREW on QC for Top Lid (Black New)
5	598766401	(ADAPTER 1/2-3/4-1 Tap adaptor H2G-08)
6	598766402	(ADAPTER 3/4" Tap Adapter GHTF USA/Canada H2G-08-01)

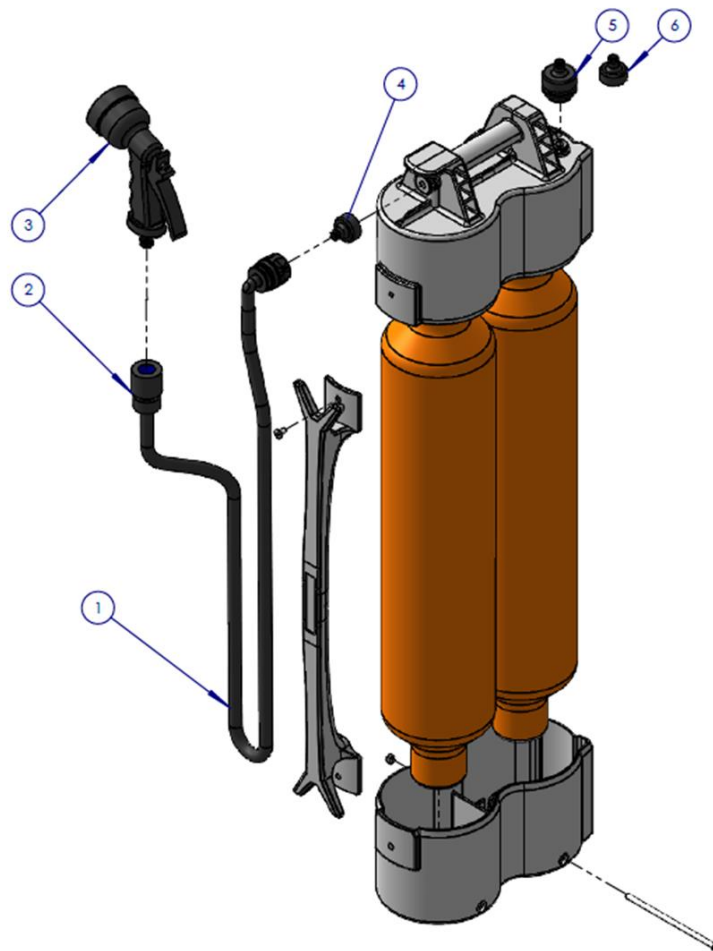



CONTACT INFORMATION

For sales, service, warranty and part orders, please contact your local Husqvarna agent

